

CASH® Magnum Auto

User manual



©2021 Frontmatec Accles & Shelvoke Ltd



**DO NOT ATTEMPT TO USE THESE STUNNING TOOLS UNTIL
YOU HAVE READ AND UNDERSTOOD THE USER MANUAL**

SECTION	DESCRIPTION	PAGES
	CONTENTS	2
1	PRODUCT DESCRIPTION	3
2	PRODUCT SPECIFICATION	4
3	PRODUCT DIAGRAM	5
4	ANIMAL WELFARE	6
5	EFFECTIVE STUNNING & CARTRIDGE SELECTION	7
6	GENERAL SAFETY PRECAUTIONS	14
7	SAFE OPERATING INSTRUCTIONS	16
8	CLEANING & GENERAL MAINTENANCE	20
9	TROUBLESHOOTING	23
10	SERVICING	25
11	SPARE PARTS LIST AND DIAGRAM	26
12	CONTACT DETAILS, WARRANTY AND RECYCLING	27
	DECLARATION OF CONFORMITY CERTIFICATE	28

DISCLAIMER

This instruction manual is correct at the time of printing. However, because our policy is one of constant development and improvement, details and images may vary slightly from those provided in this publication.

© Copyright of Accles & Shelvoke Ltd 2020 - All rights reserved Accles & Shelvoke, **CASH®**, **CASH®** Magnum Auto are all trademarks of Accles & Shelvoke Ltd

ONLY EVER USE GENUINE ACCLES & SHELVOKE REPLACEMENT PARTS. NOT USING GENUINE PARTS MAY LEAD TO PREMATURE COMPONENT AND TOOL FAILURE, WHICH COULD ENDANGER THE OPERATOR AND THOSE IN THE IMMEDIATE VICINITY. IT WILL ALSO INVALIDATE OUR ORIGINAL EQUIPMENT WARRANTY.

ACCLES & SHELVOKE WILL ACCEPT NO LIABILITY IF ANY COMPONENTS OTHER THAN THOSE SUPPLIED BY ACCLES & SHELVOKE ARE USED WITH OUR ORIGINAL EQUIPMENT. THE RESULTANT LIABILITY WILL BE WITH THE END USER OR THE DISTRIBUTOR WHO SUPPLIED THE UNAPPROVED REPLACEMENT PARTS.

The **CASH®** Magnum Auto range of stunners are cartridge powered, trigger operated, cylindrical style penetrative tools with automatic bolt return. They are available in .22" and .25" calibre and can be used on a range of animals from sheep and goats to heavy cattle. These tools are intended for professional use.

Product	Product code	Product description	Calibre	Maximum permitted cartridge
CASH® Magnum Auto	5652AS	CASH® Magnum Auto SF .22R	0.22	4.5 grain (.22 BLACK)
	5652R	CASH® Magnum Auto .22R	0.22	4.5 grain (.22 BLACK)
	5660	CASH® Magnum Auto .25R	0.25	4.5 grain (.25 GREEN)
	5660S	CASH® Magnum Auto SF .25R	0.25	4.5 grain (.25 GREEN)

The **CASH®** Magnum Auto range of stunning tools are penetrative captive bolt devices which cause severe and irreversible damage to the brain. These tools are designed to stun all designated animals prior to slaughter or depopulation. They can be used in accordance with EU Council Regulation (EC) number 1099/2009 On the Protection of Animals at the Time of Killing.

SF Models 5652AS and 5660S feature a 'stop fire' mechanism. This is a quarter - turn operated mechanism that when the operator chooses to can set the tool in stop fire mode. In this mode the firing pin is prevented from striking the cartridge thus preventing firing of the tool rendering it safe. Please refer to section 7 for further details.

The **CASH®** Magnum Auto range of stunners have been on the market for many years and in that time have earned a reputation for being a robust, reliable and effective tool. It can be used with a range of cartridges for different animal sizes.

To ensure the safety of the operator, and quality of products, all Accles & Shelvoke stunning tools are proof tested in accordance with the Rules of Proof 2006. We have several 'assistant proof masters' who are accredited by the British Proof House (formerly the Birmingham Proof House, www.gunproof.com). We work to standards set by the Commission Internationale Permanente pour l'Epreuve des Armes à Feu Portatives (CIP). All stunning tools are "Proofed" prior to the stunners being released to customers. Proofed components are stamped with the mark of the British Proof House, so that users can be assured of the quality and safety of the product.



Humane Slaughter Association

The HSA is the only UK charity which promotes the humane treatment of all food animals worldwide, including cattle, sheep, pigs, poultry, fish and minority species such as deer, beyond the farm gate. It promotes the highest animal welfare standards in markets, during transport, slaughter, and killing for welfare reasons and disease control. The HSA works through research, education, training and technical advances to bring real, practical and lasting improvements in food animal welfare.

The HSA produces a wide range of printed publications, many of which are available to download free of charge.

The Humane Slaughter Association – *Caring Beyond the Farm Gate*

[Introduction - Humane Slaughter Association \(hsa.org.uk\)](http://hsa.org.uk)

[Captive-Bolt Stunning of Livestock - Publications - Shop \(hsa.org.uk\)](http://hsa.org.uk)

Attribute	Stunner model number			
	5652AS	5652R	5660	5660S
Length (mm)	370	370	370	370
Width (mm) at widest point	60	60	60	60
Weight (kg)*	2.9	2.8	2.8	2.9
"A" weighted Sound Pressure Level at work station (dB)	87	87	87	87
"A" weighted Sound Power level (dB)	81	81	81	81
"C" weighted peak emission (dB)	119	119	119	119
Calibre	.22	.22	.25	.25
Chamber	Reduced	Reduced	Reduced	Reduced
Stop fire mechanism	Yes	No	No	Yes

*Rounded to 1 decimal place

Sound values determined according to EN 15895 using EN ISO 3744, using the maximum rated cartridge for a given tool. Tests conducted using simulated load (paper sheets and plasticine).

The A-weighted sound pressure level and A-weighted sound power level have been calculated - and are hence valid - at the maximum number of driving processes in one second.

The maximum number of driving processes in the **CASH®** Magnum Auto is one per second. This applies to all of the tools in the range included in this manual.

Information about vibrations

EN15895 states - for cartridge operated hand tools, the vibration total value to which the hand-arm system is subjected does not exceed 2.5 m/s². The generated mechanical recoil that is transmitted into the hand and arm of the operator is not considered to be a vibration.

CASH® Magnum Auto

FIG. 3.01



 THE MAXIMUM GRAINS (GRN) AND SERIAL NUMBER OF THE TOOL CAN BE FOUND ENGRAVED ON THE BARREL OF THE STUNNER

 WARNING DO NOT USE TOOL IF DEFECTIVE AND DECOMMISSION

 WARNING REPAIRS TO THIS TOOL SHOULD ONLY BE CONDUCTED BY QUALIFIED PERSONS

DANGER ZONE!
 Assuming buffers have been mistakenly omitted from the tool

NOTE - every tool in the **CASH®** range is stamped with the maximum permitted (PROOF) cartridge, showing the maximum grains (GRN) that should be used.

 NEVER USE A MORE POWERFUL CARTRIDGE THAN THE MAXIMUM PERMITTED CARTRIDGE AS STAMPED ON YOUR STUNNING TOOL

 NEVER POINT THE MUZZLE END OF THE STUNNING TOOL AT YOURSELF OR ANY OTHER PERSON

 DO NOT GRIND THE OUTSIDE DIAMETER OF THE BOLT

©2018 Accles & Shelvoke

Improving the protection of animals at the time of slaughter contributes to higher meat quality.

EU Only - in accordance with EU Council Regulation (EC) number 1099/2009 On the Protection of Animals at the Time of Killing, animals must be spared any avoidable pain, distress or suffering during their killing and related operations.

Business operators shall in particular take the necessary measures to ensure that animals:

- Are provided with physical comfort and protection, in particular by being kept clean, in adequate thermal conditions and prevented from falling or slipping
- Are protected from injury
- Are handled and housed taking into consideration their normal behaviour
- Do not show signs of avoidable pain or fear or exhibit abnormal behaviour
- Do not suffer from prolonged withdrawal of feed and water
- Are prevented from avoidable interaction with other animals that could harm their welfare

In addition:

- Bring the animal into the stun box only when the operator is ready to stun it
- Avoid excessive light and noise at the stun box to keep animal stress to a minimum
- The operator should not have to concentrate on keeping his balance, or have to bend excessively each time he stuns an animal, as this becomes tiring and can lead to inaccurate stunning. Stun box and race design is therefore of utmost importance for both animal welfare and the operator's health and safety
- The efficiency of each stunner is essential to ensuring an effective stun. Adhere to the cleaning and maintenance schedules detailed within this instruction manual
- Ensure at least 2 stunning tools are present near the stun box. If one stunner breaks down in use, then there must be a working second tool available, to ensure there is always a means of administering an effective stun to the target animal

NOTE - we always advise you to refer to any local regulations in force.

This section provides a guide to the correct stunning position and direction for certain animals, and helps you to select the correct cartridge for that animal.

The cartridge selection information provided within this section of this instruction manual is not categorical and is hence supplied as guidance only.

GOOD PRACTICE

- Understand animal welfare - refer to section 4 for further guidance
- Always ensure your stunning tool is in good working order
- Stunning tools should be cleaned and maintained in accordance with the instructions within this manual
- Ensure at least 2 stunning tools are present near the stunning box
- Stunning tools will require more maintenance if used with cartridges that are more powerful than is necessary for the target animal

EFFECTIVE STUNNING

The cartridge selection and the blow being applied to the correct part of the skull and in the right direction is important in ensuring an effective stun. Refer to the diagrams and selection charts within this section as guidance towards selection. To obtain maximum effect, the barrel of the tool must always be held firmly against the head.

The physical signs of an effective stun are:

Quadrupeds

- Animal collapses
- No rhythmic breathing
- Fixed, glazed expression in the eyes
- No corneal reflex
- Relaxed jaws
- Tongue hanging loose



THE EFFECTIVENESS OF THE STUN MUST BE VERIFIED BEFORE THE ANIMAL IS SLAUGHTERED

FAILURE TO STUN

If an animal is not properly stunned it must be re-stunned immediately. Using the second or an alternative stunning tool, a repeat shot must always be placed so as to avoid the immediate area of the first shot.

STUN-TO-STICK TIMES

The humane killing of livestock using captive bolt equipment is a two-stage procedure. After the animal has been stunned, it must be bled (or pithed*) immediately to ensure rapid death.

The stun-to-stick interval is the time from application of stunning equipment to the start of bleeding. After stunning, sticking should be conducted without delay with a maximum stun-to-stick interval of 15 seconds recommended for all species in the field. In the abattoir, all pigs, sheep and goats should also be stuck within 15 seconds. However, on the majority of cattle lines, where the carcass must be hoisted to a bleed area, maximum stun-to-stick intervals of 60 seconds for the penetrative captive-bolt and 30 seconds for the non-penetrative captive-bolt are acceptable. (These figures are obtained from the Humane Slaughter Association (HSA) website).

*Dependant upon localised regulations in force.

CORRECT STUNNING POSITION
CATTLE

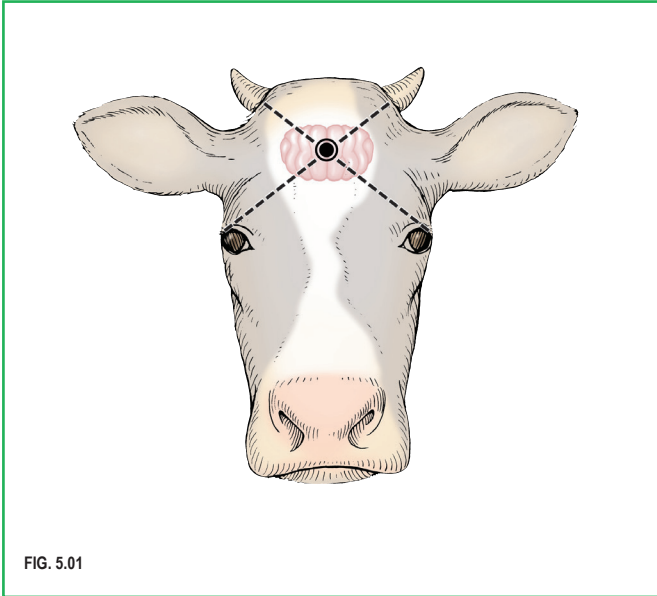

FIG. 5.01

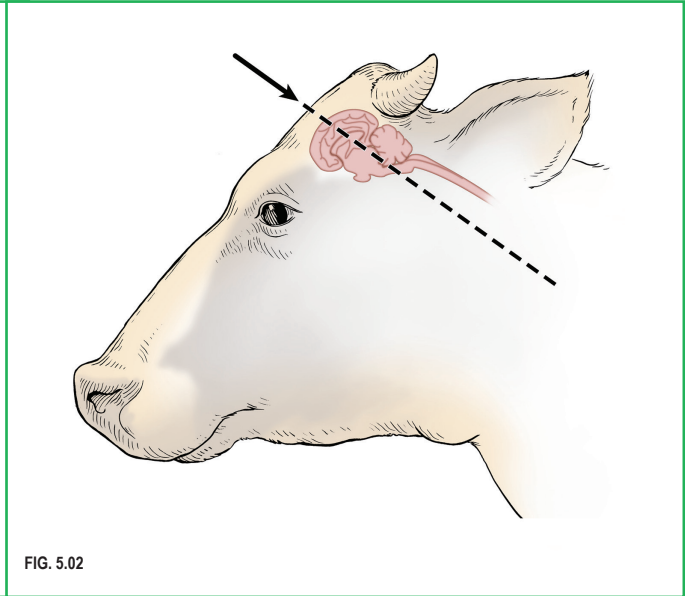





FIG. 5.02

Illustration courtesy of J. K. Shearer, Iowa State University

	.22" range		.25" range	
	CASH® Magnum Auto SF .22R 5652AS	CASH® Magnum Auto .22R 5652R	CASH® Magnum Auto .25R 5660	CASH® Magnum Auto SF .25R 5660S
For calves				
For light animals	Pink	Pink	Pink	Pink
For medium animals	Purple	Purple	Yellow	Yellow
For heavy animals and bulls	Green	Green	Blue	Blue
For very heavy animals	Red	Red	Orange	Orange
For extremely heavy animals	Black	Black	Black	Black
For exceptionally heavy animals	N/S	N/S	Green	Green
For exceptionally heavy animals	N/S	N/S	N/S	N/S

N/S: Not Suitable for denoted animal size

CORRECT STUNNING POSITION
PIGS

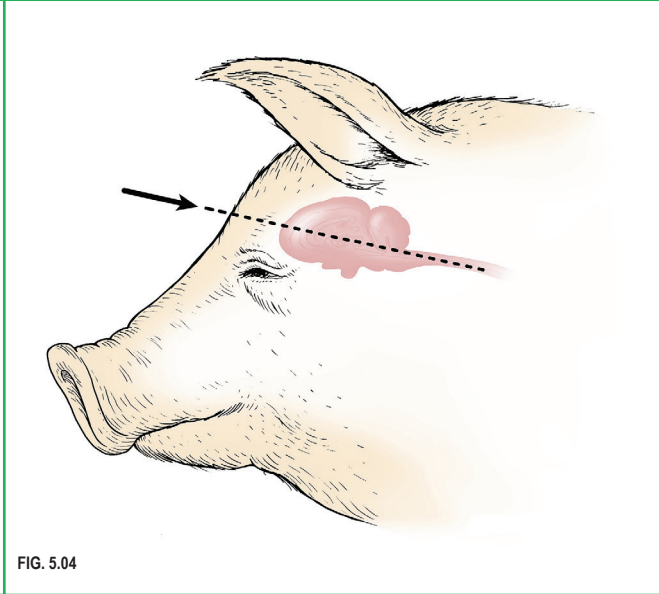
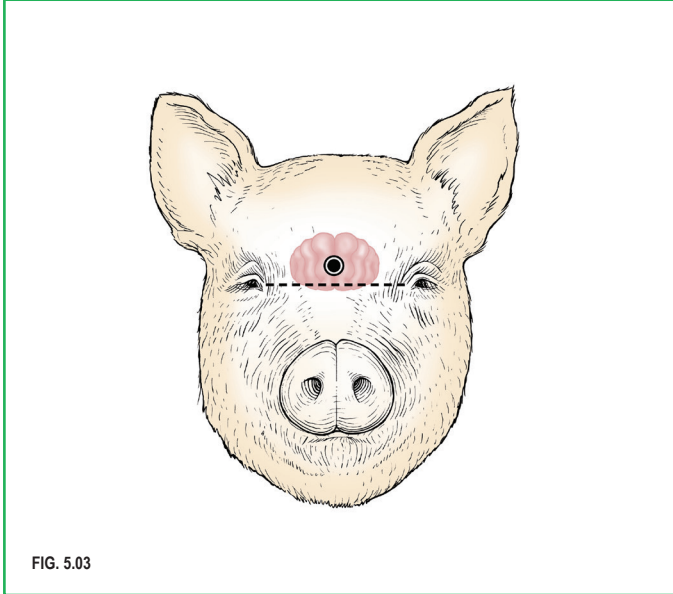

Illustration courtesy of J. K. Shearer, Iowa State University

	.22" range		.25" range	
	CASH® Magnum Auto SF .22R 5652AS	CASH® Magnum Auto .22R 5652R	CASH® Magnum Auto .25R 5660	CASH® Magnum Auto SF .25R 5660S
For piglets				
For piglets	Brown	Brown	Pink	Pink
For weaners and growers	Pink/purple	Pink/purple	Yellow	Yellow
For market pigs	Green	Green	Orange	Orange
For heavy animals	Red	Red	Black	Black
For very heavy sows and boars	Black	Black	Green	Green
For exceptionally heavy animals	N/S	N/S	N/S	N/S

N/S: Not Suitable for denoted animal size

CORRECT STUNNING POSITION
SHEEP AND GOATS

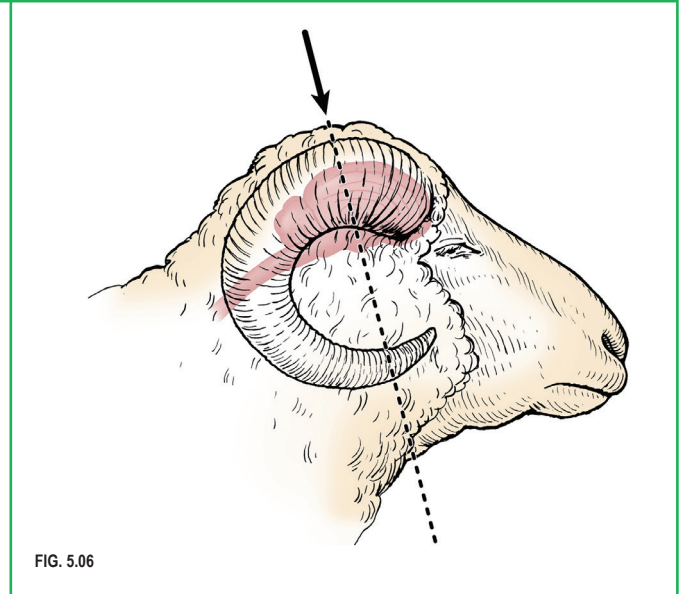
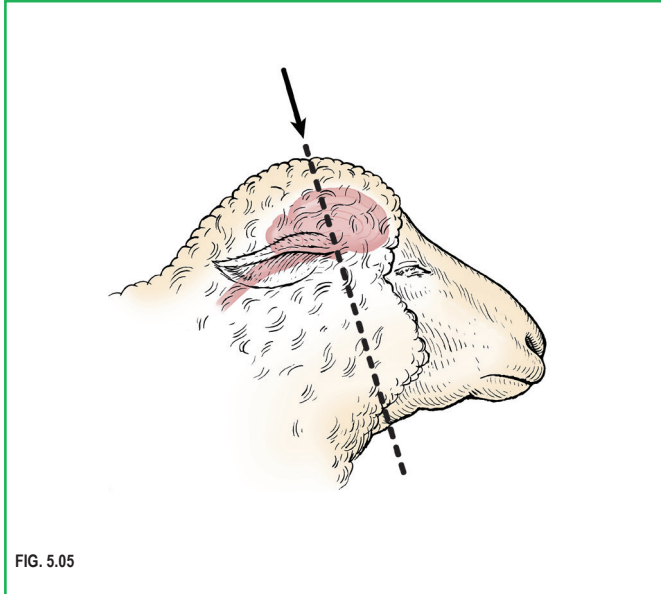

Illustration courtesy of J. K. Shearer, Iowa State University

	.22" range		.25" range	
	CASH® Magnum Auto SF .22R 5652AS	CASH® Magnum Auto .22R 5652R	CASH® Magnum Auto .25R 5660	CASH® Magnum Auto SF .25R 5660S
For lambs and kids				
For lambs and kids	Brown	Brown	Pink	Pink
For other lambs and kids	Pink	Pink	Pink	Pink
For ewes	Pink/purple	Pink/purple	Pink/yellow	Pink/yellow
For rams	Purple	Purple	Yellow	Yellow
For goats	Purple	Purple	Yellow	Yellow

N/S: Not Suitable for denoted animal size

OTHER ANIMAL SPECIES

Although Accles & Shelvoke stunning tools are predominantly used for the stunning of cattle, sheep and pigs for meat production, we know from our 100 year history that they are also used for other animal species, such as, but not limited to:

Mammals such as

- Equines
- Deer
- Camelids
- Etc.

Large fish such as

- Sturgeon
- Tuna
- Etc.

Large reptiles such as

- Alligators
- Crocodiles
- Monitor lizards
- Etc.

As conclusive test results are not available for these animals, we recommend you seek the advice of an independent expert to understand the appropriate cartridge selection, head placement and tool direction, prior to stunning.

ACCLES & SHELVOKE CARTRIDGE RANGE

The tables on the next pages identify which cartridges from our range are suitable for use with a given tool from the **CASH®** Magnum Auto range of products. The cartridges are supplied in quantities of 50 in a metal tin, or 1000 in a box. All of our products will be clearly branded as Accles & Shelvoke **CASH®** cartridges. **CASH®** cartridges conform to EN16264.

It is a condition of Accles & Shelvoke's product liability insurance that only **CASH®** cartridges, in **CASH®** cartons and bearing "E" or "C" headmarks, be used in stunners manufactured by Accles & Shelvoke. It follows therefore, that no liability whatsoever can be accepted for any claim, including injury, should any other brand of cartridge be used.

Where cartridges other than these are used, Accles & Shelvoke will not accept responsibility for:

- The safety of the operator
- The humaneness of the stun
- The correct operation of the stunning tool
- The premature failure of parts

Cartridges must be stored in cool, dry conditions. Exposure to excessive amounts of moisture may affect cartridge performance, which in turn will affect tool performance with the potential to create an ineffective stun of the animal.

When not in use, cartridges should be locked away separately from any stunning tools.

NOTE - "N/S" - with reference to the compatibility tables in this section of the manual, "N/S" identifies that the cartridges highlighted are not suitable for use in the stated **CASH®** product in the table.



EXCEEDING THE PERMITTED STRENGTH OF CARTRIDGE COULD BE HAZARDOUS TO THE OPERATOR, WILL REDUCE THE EXPECTED LIFE OF THE TOOL OR ITS COMPONENTS AND WILL INVALIDATE OUR WARRANTY

STUNNING TOOL AND CARTRIDGE COMPATABILITY - .22" CALIBRE

Calibre	Product code	Description	Grain	1	1.25	2.25	3	4	4.5
				Pink	Yellow	Blue	Orange	Black	Red
0.22"	5652AS	CASH® Magnum Auto SF .22R		YES					
0.22"	5652R	CASH® Magnum Auto .22R		YES					

PART NUMBERS FOR .22" CARTRIDGES BY QUANTITY

To order your .22" calibre cartridges, please select the appropriate part number from the table below:

Size/Grain	Colour	50 in a tin	1000 in a box
1	Brown	7505T	7505
1.25	Pink	7585T	7585
2.25	Purple	7565T	7565
3	Green	7632T	7632
4	Red	7645T	7645
4.5	Black	7653T	7653

STUNNING TOOL AND CARTRIDGE COMPATABILITY - .25" CALIBRE

Calibre	Product code	Description	Grain	1	1.25	2.25	3	4	4.5	
				Pink	Yellow	Blue	Orange	Black	Red	
0.25"	5660	CASH® Magnum Auto .25R		YES						N/S
0.25"	5660R	CASH® Magnum Auto SF .25R		YES						N/S

PART NUMBERS FOR .25" CARTRIDGES BY QUANTITY

To order your .25" calibre cartridges, please select the appropriate part number from the table below:

Size/Grain	Colour	50 in a tin	1000 in a box
1.25	Pink	4121KA	7760
2	Yellow	4121KB	7710
3	Blue	4121KC	7757
3.5	Orange	4121KD	7754
4	Black	7754T	7754
4.5	Green	7725T	7725

KEY PARAMETERS FOR CARTRIDGE SELECTION

The table on this page details the key performance parameters for the **CASH®** Magnum Auto when used in conjunction with approved Accles & Shelvoke cartridges.

This information is issued to satisfy the requirements of EU Council Regulation (EC) number 1099/2009 On the Protection of Animals at the Time of Killing. It provides guidelines to aid the selection of an appropriate cartridge to perform effective killing on a particular type and size of animal. Whilst we believe this regulation is open to interpretation, these parameters have been published following years of experience.

These figures may only be used when quoted with the associated notes. Accles & Shelvoke will not accept responsibility for the reliability of these figures if used out of context.

Product code	Calibre	Cartridge grains (nominal)	Frontmatec Accles & Shelvoke cartridge colour	#Bolt (head) diameter (mm)	Average bolt velocity* (m/s)	Minimum bolt exit length** (mm)	Energy generated (J)
5652AS 5652R	.22"	1	Brown	11.4	29.9	65	98
		1.25	Pink		42.7		213
		2.5	Purple		48.2		271
		3	Green		53.4		332
		4	Red		59.1		407
		4.5	Black		59.9		418

Product code	Calibre	Cartridge grains (nominal)	Frontmatec Accles & Shelvoke cartridge colour	#Bolt (head) diameter (mm)	Average bolt velocity* (m/s)	Minimum bolt exit length** (mm)	Energy generated (J)
5660 5660S	.25"	1.25	Pink	11.4	36.6	65	156
		2	Yellow		48.7		276
		3	Blue		53.1		329
		3.5	Orange		56.6		374
		4	Black		64.4		483
		4.5	Green		67.6		533

NOTES

* When measured in air over a distance of 47 mm, 15 mm from the muzzle tip of the tool

** When fired in air

These quoted figures have been established during extensive testing at the Accles & Shelvoke factory test facility.

The velocity figures quoted are accurate within +/- 15%, when using a stunning tool that is in good condition and maintained in accordance with this manual.



DO NOT ATTEMPT TO USE THIS STUNNING TOOL UNTIL YOU HAVE READ AND UNDERSTOOD THESE INSTRUCTIONS



- ALWAYS WEAR THE CORRECT PERSONAL PROTECTIVE EQUIPMENT (PPE) WHENEVER YOU ARE WORKING WITH, CLEANING OR MAINTAINING YOUR CASH® TOOL
- ALWAYS WEAR PROTECTIVE GLASSES AND HEARING PROTECTION. THE CORRECT FOOT PROTECTION MUST BE WORN THERE IS A RISK THAT IF THE TOOL IS DROPPED, THE BOLT MAY PENETRATE THE FOOT OF THE TOOL USER



ALWAYS POINT THE TOOL AWAY FROM YOUR BODY AND AWAY FROM ANY OTHER PERSON IN THE VICINITY WHEN HANDLING OR OPERATING THE TOOL

GENERAL SAFETY STATEMENT

- ANYONE GRANTED THE AUTHORITY TO USE ONE OF THESE TOOLS SHOULD HAVE READ THIS MANUAL SUCH THAT THEY ARE MADE FULLY AWARE OF THE POTENTIAL RISKS
- THIS TOOL HAS THE POTENTIAL TO CAUSE SEVERE INJURY OR FATALITY IF USED IMPROPERLY OR INAPPROPRIATELY OUTSIDE OF ITS INTENDED SCOPE OF USE



DANGER - The hazards listed in this section pose a high level of risk which, if not avoided, will result in death or serious injury

- NEVER POINT THE TOOL AT YOURSELF OR ANY OTHER PERSON - THE BOLT WILL DELIVER A VERY HARMFUL BLOW WHICH MAY LEAD TO SEVERE AND IRREVERSIBLE DAMAGE, POSSIBLY LEADING TO FATALITY
- NEVER FIRE THE TOOL IN AN AREA DESIGNATED AS FLAMMABLE OR CONTAINING EXPLOSIVES
- NEVER PASS THE TOOL TO ANY OTHER PERSON WHEN IT IS COCKED AND READY TO FIRE - ACCIDENTAL FIRING OF THE BOLT MAY DELIVER A VERY HARMFUL BLOW WHICH MAY LEAD TO SEVERE AND IRREVERSIBLE DAMAGE POSSIBLY LEADING TO FATALITY
- NEVER LEAVE A CARTRIDGE, WHETHER LIVE OR FIRED, IN THE BREECH - TO PREVENT ACCIDENTAL FIRING OF THE BOLT
- TOOLS SHOULD BE FIRED AS FAR AWAY FROM THE BODY AS IS COMFORTABLE AND ALWAYS POINTING AWAY FROM THE OPERATOR - FIRING OF THE BOLT TOWARD BODY PARTS MAY DELIVER A VERY HARMFUL BLOW WHICH MAY LEAD TO SEVERE AND IRREVERSIBLE DAMAGE, POSSIBLY LEADING TO FATALITY
- NEVER MODIFY OR CUSTOMISE THE TOOL - THIS MAY RENDER THE TOOL UNSTABLE AND UNSAFE FOR USE, WITH THE POTENTIAL TO FIRE ACCIDENTALLY. IT WILL ALSO INVALIDATE YOUR WARRANTY
- ENSURE YOU ARE BALANCED AND STABLE PRIOR TO FIRING TO AID TOOL POSITIONING ACCURACY. AVOID OVER-STRETCHING AND UNFAVOURABLE BODY POSITIONS - TO MINIMISE THE RISK OF DROPPING THE TOOL AND/OR ACCIDENTAL FIRING
- CARTRIDGE MISFIRES - IF THE CARTRIDGE HAS MISFIRED (NOT FIRED), PUT THE TOOL DOWN IMMEDIATELY AND WAIT FOR 30 SECONDS BEFORE FOLLOWING THE PROCEDURE IN SECTION 9 OF THIS MANUAL - TO AVOID DELAYED FIRING OF THE CARTRIDGE - WHICH MAY CAUSE SEVERE DAMAGE IF FIRING OCCURS WHILST BEING HANDLED
- DO NOT PLACE THE TOOL DOWN ONTO A WORK SURFACE WHEN IT IS COCKED AND READY TO FIRE - IF THE TRIGGER IS DEPRESSED WHEN PLACED DOWN, THE TOOL WILL FIRE AND THE BOLT WILL DELIVER A HARMFUL BLOW TO ADJACENT BODY PARTS



- ALWAYS WEAR THE CORRECT PERSONAL PROTECTIVE EQUIPMENT (PPE) WHENEVER YOU ARE WORKING WITH, CLEANING OR MAINTAINING YOUR CASH® TOOL
- ALWAYS WEAR PROTECTIVE GLASSES AND HEARING PROTECTION. THE CORRECT FOOT PROTECTION MUST BE WORN THERE IS A RISK THAT IF THE TOOL IS DROPPED, THE BOLT MAY PENETRATE THE FOOT OF THE TOOL USER



DANGER - If the tool is set in the cocked (ready to fire) position and is dropped, there is a potential risk to the operator and/or people within the immediate vicinity of the dropped tool. The hazards listed in this section pose a high level of risk, which if not avoided will result in serious injury

- IF IT DROPS AND LANDS ON THE TRIGGER, THE TOOL WILL FIRE AND THE BOLT WILL BE PROPELLED OUT OF THE TOOL AT A VERY HIGH VELOCITY. THE BOLT HAS THE POTENTIAL TO WILL DELIVER A VERY PAINFUL BLOW TO THE FEET OR LEGS IF THEY ARE WITHIN 75 MM OF THE BOLT WHEN IT FIRES OUT OF THE TOOL THEY ARE HIDDEN FROM PUBLIC VIEW, ie NO-ONE OUTSIDE OF THE VEHICLE CAN SEE THE LOCKABLE CONTAINERS WITHIN THE VEHICLE

Our advise to minimise the risk

- IF THE TOOL IS DROPPED, LET IT FALL, DO NOT TRY TO CATCH IT
- STEP AS FAR AWAY (AS IT IS SAFE TO) FROM THE TOOL AS IT FALLS, BUT WATCH IT HIT THE FLOOR
- TAKE APPROPRIATE AVOIDABLE ACTION IF TOOL REBOUNDS
- DO NOT APPROACH THE TOOL UNTIL IT IS STATIONARY
- AFTER BEING DROPPED, CHECK THAT THE CONCUSSION HEAD OF THE BOLT IS NOT DAMAGED
- ENSURE THE TOOL IS WORKING CORRECTLY BEFORE RECOMMENCING USE
- IF IN DOUBT, THE TOOL SHOULD BE CHECKED AND REPAIRED AS NECESSARY



WARNING - The hazards listed in this section pose a medium level of risk which, if not avoided may result in recoverable injury

- DO NOT FIRE THE BOLT INTO HARD, BRITTLE OR IMPENETRABLE MATERIALS - AS THE BOLT MAY FRAGMENT AND POSE A DANGER OF FLYING PARTICLES
- NEVER USE A MORE POWERFUL CARTRIDGE THAN THE MAXIMUM PERMITTED CARTRIDGE AS STAMPED ON YOUR TOOL - TO PREVENT CARTRIDGE BURST AND EXCESSIVE NOISE IN OPERATION
- KEEP THE TOOL DRY AND CLEAN - TO ENSURE YOU HAVE AN ADEQUATE GRIP ON THE TOOL DURING USE AND MINIMISE THE RISK OF DROPPING THE TOOL
- WHEN PLACING THE ASSEMBLED TOOL – OR IF THE TOOL HAS BEEN SEPARATED THE CAP OR BARREL (REFER TO FIG 3.01) – DOWN ONTO A WORK SURFACE ENSURE THERE IS A MEANS TO PREVENT THE TOOL OR TOOL PARTS FROM ROLLING OFF THE WORK SURFACE. IF THE TOOL FALLS OR DROPS FROM THE WORK SURFACE, IT MAY DROP ONTO THE FOOT OF THE OPERATOR OR OTHER PEOPLE IN THE VICINITY



CAUTION - The hazards listed in this section pose a low level of risk which, if not avoided may result in minor or moderate injury

- KEEP FINGERS AWAY FROM BENEATH THE FIRING PIN PULL WHEN THE TOOL IS COCKED AND READY TO FIRE TO PREVENT TRAPPING



- ALWAYS WEAR THE CORRECT PERSONAL PROTECTIVE EQUIPMENT (PPE) WHENEVER YOU ARE WORKING WITH, CLEANING OR MAINTAINING YOUR CASH® TOOL
- ALWAYS WEAR PROTECTIVE GLASSES AND HEARING PROTECTION. THE CORRECT FOOT PROTECTION MUST BE WORN THERE IS A RISK THAT IF THE TOOL IS DROPPED, THE BOLT MAY PENETRATE THE FOOT OF THE TOOL USER



ALWAYS POINT THE TOOL AWAY FROM YOUR BODY AND AWAY FROM ANY OTHER PERSON IN THE VICINITY WHEN HANDLING OR OPERATING THE TOOL

GENERAL PRECAUTIONS AND GOOD PRACTICE

Improper use

- ONLY EVER USE THIS TOOL FOR THE STUNNING OF LIVE ANIMALS
- ONLY EVER USE GENUINE ACCLES & SHELVOKE SUPPLIED CARTRIDGES AND SPARES
- DO NOT FIRE "AIR SHOTS" (FIRING OF THE BOLT INTO AIR) AS THIS WILL REDUCE THE WORKING LIFE OF THE TOOL AND ITS COMPONENTS

Workplace precautions

- THE TOOL SHOULD BE USED IN WELL ILLUMINATED AND WELL VENTILATED WORKPLACE ENVIRONMENTS
- ENSURE THE WORKPLACE IS FREE OF UNNECESSARY OBSTACLES OR TRIP HAZARDS

Operational precautions

- ONLY LOAD CARTRIDGES WHEN THEY ARE READY TO BE USED
- IF A CARTRIDGE STICKS IN THE BREECH AND WILL NOT EJECT, DO NOT USE A SHARP INSTRUMENT TO REMOVE IT. THE TOOL SHOULD BE REMOVED IN ACCORDANCE WITH THESE INSTRUCTIONS IN SECTION 9 - TROUBLESHOOTING
- TOOLS MAY BE USED IN AN ALTERNATING SYSTEM AS PART OF A PLANNED OPERATING CYCLE
- JOB ROTATION MAY HELP MAINTAIN THE APPROPRIATE HIGH LEVELS OF CONCENTRATION REQUIRED AT THE WORKPLACE, HELPING TO MINIMISE ANY RISK DUE TO TIREDNESS OR FATIGUE

Good practice

- THE CLEANING AND MAINTENANCE SCHEDULE DETAILED IN THIS MANUAL SHOULD BE ADHERED TO, TO ENSURE THE TOOL OPERATES SAFELY AND CORRECTLY TO PROVIDE EFFECTIVE ANIMAL STUNNING
- AT THE END OF A WORKING SHIFT, OR IF THE TOOL IS NOT GOING TO BE USED FOR PROLONGED PERIODS, THE UNCOCKED AND UNLOADED TOOL SHOULD BE STORED IN COOL DRY CONDITIONS AND LOCKED SECURELY IN A WAY THAT NO UNAUTHORISED ACCESS TO THE TOOL IS POSSIBLE
- CARTRIDGES SHOULD BE LOCKED AWAY SEPARATELY FROM THE STUNNING TOOL IN COOL, DRY CONDITIONS
- EXPOSURE TO EXCESSIVE AMOUNTS OF MOISTURE MAY AFFECT CARTRIDGE PERFORMANCE WHICH IN TURN WILL AFFECT TOOL PERFORMANCE, WITH THE POTENTIAL TO CREATE AN INEFFECTIVE STUN OF THE ANIMAL. WET CARTRIDGES WILL NOT FIRE AND SHOULD NOT BE USED
- ALWAYS WASH YOUR HANDS AFTER USING ANY STUNNING TOOL TO ENSURE CLEANLINESS

Transportation of stunning tools and cartridges between sites

THIS TOOL HAS BEEN SUPPLIED TO YOU WITH THE INTENTION OF SINGLE SITE USE - SUPPLIED WITHOUT A LOCKABLE STORAGE CONTAINER. SHOULD THERE BE A NEED TO TRANSPORT THIS TOOL AND LIVE CARTRIDGES BY ROAD BETWEEN SITES, WE ADVISE:

- PRIOR TO TRANSPORTATION, YOU SHOULD SEEK THE APPROPRIATE ADVICE CONCERNING APPLICABLE LOCAL LAWS AND REGULATIONS IN FORCE ON THE TRANSPORTATION OF CARTRIDGES TO BE USED FOR ANIMAL STUNNING
- THE TOOL AND CARTRIDGES ARE TRANSPORTED IN SEPARATE LOCKABLE CONTAINERS
- THEY ARE HIDDEN FROM PUBLIC VIEW, ie NO-ONE OUTSIDE OF THE VEHICLE CAN SEE THE LOCKABLE CONTAINERS WITHIN THE VEHICLE



DO NOT ATTEMPT TO USE THIS STUNNING TOOL UNTIL YOU HAVE READ AND UNDERSTOOD THESE INSTRUCTIONS



- ALWAYS WEAR THE CORRECT PERSONAL PROTECTIVE EQUIPMENT (PPE) WHENEVER YOU ARE WORKING WITH, CLEANING OR MAINTAINING YOUR **CASH®** TOOL
- ALWAYS WEAR PROTECTIVE GLASSES AND HEARING PROTECTION. THE CORRECT FOOT PROTECTION MUST BE WORN THERE IS A RISK THAT IF THE TOOL IS DROPPED, THE BOLT MAY PENETRATE THE FOOT OF THE TOOL USER



WHEN PLACING THE ASSEMBLED TOOL – OR IF THE TOOL HAS BEEN SEPARATED THE CAP OR BARREL (REFER TO FIG 3.01) – DOWN ONTO A STORAGE SURFACE ENSURE THERE IS A MEANS TO PREVENT THE TOOL OR TOOL PARTS FROM ROLLING OFF THE STORAGE SURFACE. IF THE TOOL FALLS OR DROPS FROM THE STORAGE SURFACE, IT MAY DROP ONTO THE FOOT OF THE OPERATOR OR OTHER PEOPLE IN THE VICINITY.

ALWAYS POINT THE TOOL AWAY FROM YOUR BODY AND AWAY FROM ANY OTHER PERSON IN THE VICINITY WHEN HANDLING OR OPERATING THE TOOL

NOTE - The maximum recommended usage rate for **CASH®** Magnum Auto tool is 60 shots per hour using the maximum specified cartridge.

1. PREPARING FOR LOADING

- 1.1 Turn the breech cap counter clockwise and pull away. (See fig 7.01)
- 1.2 Make sure firing pin and trigger are uncocked. (See fig. 7.02)
- 1.3 If spent (fired) cartridge is in the chamber, pull extractor up and then push back down
- 1.4 The partially lifted case can then be removed

2. LOADING

- 2.1 Before inserting the cartridge into the chamber of the breech, ensure that the bolt is fully retracted. If not, do not use the tool as the stunning power will be reduced which can lead to an ineffective stun. (See fig 7.05)
- 2.2 Obtain a single cartridge, and load the cartridge into the cartridge chamber crimped end first. (See fig 7.06)

NOTE

- Only load the cartridge immediately before firing
- Keep the cartridge clean and dry before insertion into the chamber
- Visually check that the bolt is fully retracted before firing (refer to fig. 7.05)
- Only use the correct grade of **CASH®** cartridge, as shown in fig. 7.04
- When not in use, never leave a cartridge in the chamber whether live or spent
- Never leave a loaded stunner unattended

FIG. 7.01

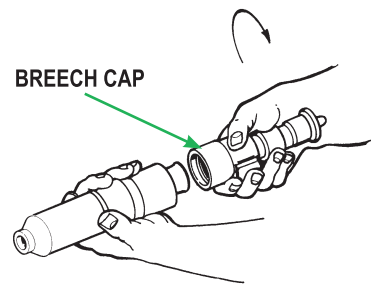

©2018 Accles & Shelvok

FIG. 7.02



UNCOCKED

FIG. 7.03



COCKED

©2018 Accles & Shelvok

©2018 Accles & Shelvok

FIG. 7.04

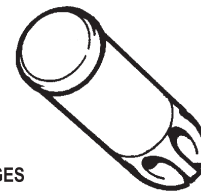

ONLY USE **CASH®** CARTRIDGES WITH **CASH®** STUNNING TOOLS

©2018 Accles & Shelvok

FIG. 7.05

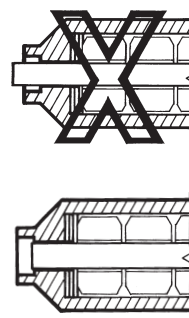

©2018 Accles & Shelvok

FIG. 7.06

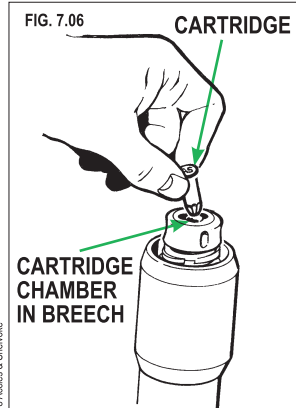

©2018 Accles & Shelvok



ALWAYS POINT THE TOOL AWAY FROM YOUR BODY AND AWAY FROM ANY OTHER PERSON IN THE VICINITY WHEN HANDLING OR OPERATING THE TOOL

3. MAKE READY FOR FIRING

- 3.1 With the tool facing away from you, align the breech cap to the barrel and screw the breech cap clockwise until securely fastened
- 3.2 With the tool facing away from you, pull the firing pin upwards until there is a "CLICK", the tool is now cocked and ready to fire. (See fig. 7.07)

NOTE

- Do not point the tool at yourself or any other person
- Keep your fingers clear of and away from the trigger when loading the cartridge
- Do not place the tool down when it is cocked and ready to fire

4. FIRE

- 4.1 Position the barrel tip into the correct position on the target animal's head and when it touches, you should instantaneously fire the tool by depressing the trigger to stun the animal

NOTE

- Refer to section 5 for the correct stunning position and angle for the target animal
- Do not attempt to FIRE if the animal is moving its head
- The barrel application must be smooth and accurate and the tool fired the instant it is in position on the target area of the head
- If the shot is aborted before depressing the trigger, unscrew the cap and remove the cartridge to make safe

FIG. 7.07

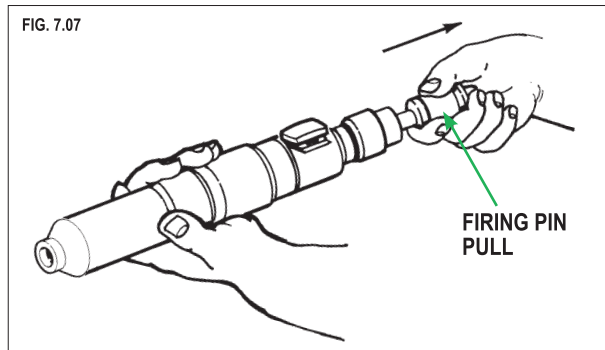

©2018 Accles & Shelvoke

FIG. 7.08

RECOMMENDED STUNNING POSITION

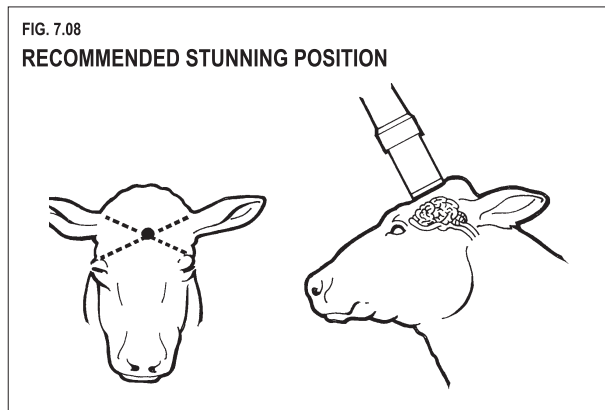

©2018 Accles & Shelvoke



ALWAYS POINT THE TOOL AWAY FROM YOUR BODY AND AWAY FROM ANY OTHER PERSON IN THE VICINITY WHEN HANDLING OR OPERATING THE TOOL

5. EXTRACTION

- 5.1 Turn the breech cap counter clockwise and pull away
- 5.2 Pull the extractor up and then push back down. (See fig. 7.09)
- 5.3 Remove the cartridge from the chamber
- 5.4 The tool is now ready for the next cartridge

NOTE

- The spent cartridge will be partially lifted by the extractor to make removal easier
- If the spent cartridge is stuck in the chamber, follow the procedure in section 9 of this manual to remove safely
- Do not use a sharp implement to remove stuck cartridges as this may damage the breech or extractor

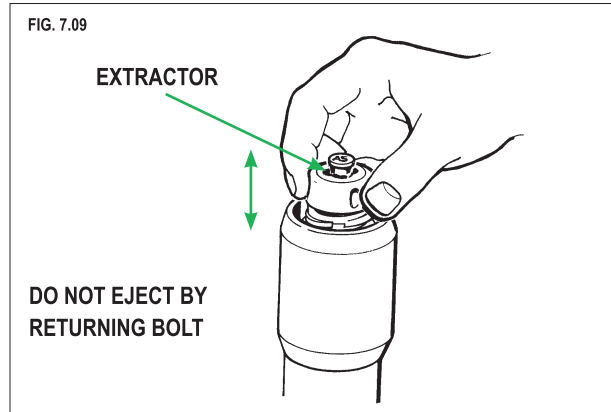

IF THE CARTRIDGE HAS MISFIRED (NOT FIRED), PUT THE TOOL DOWN IMMEDIATELY AND WAIT FOR 30 SECONDS BEFORE FOLLOWING THE PROCEDURE IN SECTION 9 OF THIS MANUAL

STOP FIRE MECHANISM

How to use and set your tool into safe mode - tool will not fire.

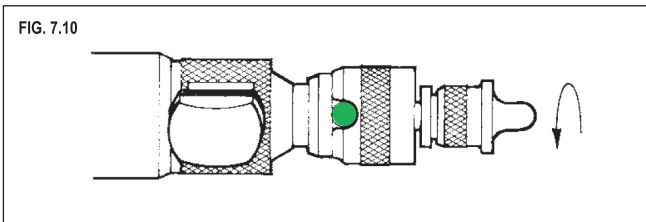

GREEN DOT - STOP FIRE MODE

Turn stop fire cap (item 14 in Spares List and Diagram in section 11) counter clockwise and the GREEN DOT can be seen in the cut-out.

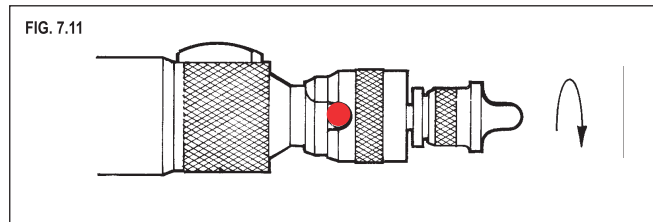

RED DOT - FIRE MODE

Turn stop fire cap (item 14 in Spares List and Diagram in section 11) clockwise until it stops turning and the RED DOT can be seen in the cut-out.



DO NOT ATTEMPT TO USE THIS STUNNING TOOL UNTIL YOU HAVE READ AND UNDERSTOOD THESE INSTRUCTIONS



- ALWAYS WEAR THE CORRECT PERSONAL PROTECTIVE EQUIPMENT (PPE) WHENEVER YOU ARE WORKING WITH, CLEANING OR MAINTAINING YOUR CASH® TOOL
- ALWAYS WEAR PROTECTIVE GLASSES AND HEARING PROTECTION. THE CORRECT FOOT PROTECTION MUST BE WORN THERE IS A RISK THAT IF THE TOOL IS DROPPED, THE BOLT MAY PENETRATE THE FOOT OF THE TOOL USER

Part no.	Description	Qty per set
5644	Cleaner assembly (includes 5645, 5646 and 5647)	1
5645	Steel cleaner brush	1
5646	Brass cleaner brush	1
5647	Cleaner handle	1
5900	Handle	1
5901	Chamber brush (.22)	1
5903	Wool mop (.22)	1
5902	Chamber brush (.25)	1
5904	Wool mop (.25)	1
4187	**CASH® pistol oil	1
4192	**Copaslip thread grease	1
6076	**Young's 303 fluid	1

NOTES

Items highlighted above are included with every CASH® Magnum Auto
 The non-highlighted items are available as maintenance spares

** Product Data Sheets available upon request

MAINTENANCE AND CLEANING RECORD

It is a requirement of EU Council Regulation (EC) number 1099/2009 On the Protection of Animals at the Time of Killing, that all stunning equipment is maintained in accordance with the manufacturers' instructions and that a log detailing the maintenance is recorded and available for external auditing purposes. We recommend you create a maintenance and cleaning record for each individual stunning tool, containing as a minimum the following information.

- Stunning product code and description
- Serial number
- Service start date (date tool was first used)
- Part replacement details - part number and description - date replacement/maintenance took place
- Stun check record - Universal Stun Check unit serial number, date checked, cartridge colour used, pass or fail
- Shots fired - total number of shots fired with the tool on a daily or weekly basis
- Name and position of person conducting the cleaning or maintenance on any given day

ONLY EVER USE GENUINE ACCLES & SHELVOKE REPLACEMENT PARTS. NOT USING GENUINE PARTS MAY LEAD TO PREMATURE COMPONENT AND TOOL FAILURE, WHICH COULD ENDANGER THE OPERATOR AND THOSE IN THE IMMEDIATE VICINITY. IT WILL ALSO INVALIDATE OUR ORIGINAL EQUIPMENT WARRANTY.

ACCLES & SHELVOKE WILL ACCEPT NO LIABILITY IF ANY COMPONENTS OTHER THAN THOSE SUPPLIED BY ACCLES & SHELVOKE ARE USED WITH OUR ORIGINAL EQUIPMENT. THE RESULTANT LIABILITY WILL BE WITH THE END USER OR THE DISTRIBUTOR WHO SUPPLIED THE UNAPPROVED REPLACEMENT PARTS.

IT IS RECOMMENDED THAT YOUR ACCLES & SHELVOKE STUNNER BE TESTED AND CERTIFICATED ANNUALLY BY THE MANUFACTURER OR BY AN APPROVED DISTRIBUTOR.



ALWAYS POINT THE TOOL AWAY FROM YOUR BODY AND AWAY FROM ANY OTHER PERSON IN THE VICINITY WHEN HANDLING OR OPERATING THE TOOL

CLEANING DAILY - CASH® Magnum Auto

1. Unscrew breech cap (item 6) from breech (item 5) and ensure that stunner is not loaded.
2. Unscrew breech anti-clockwise and remove from barrel (item 1).
3. Withdraw bolt (item 4) complete with washers (items 2 and 7) and recuperator sleeves (item 3) from the barrel. **NOTE** - The stop washers and some recuperator sleeves may have been retained in the barrel - ensure to REMOVE before cleaning.
4. Clean inside of barrel and breech including undercut in breech with a cloth soaked in pistol oil and followed with the steel brush end of cleaning tool.
5. Wipe the barrel and breech out with a clean cloth.
6. Remove the washers and recuperator sleeves from the bolt and wire wheel or brush powder residue from piston end of bolt - wipe with cloth when clean. Wipe any residue from washers and recuperator sleeves and examine for wear.
 - 6.1 Stop washer - *Red colour* (item 2) - There are three of these washers at the poleaxe (front) end of the bolt, which fit against the front internal end of the barrel. They protect the recuperator sleeves and as soon as they show signs of wear on either the inside or outside diameter, they should be replaced.
 - 6.2 Flange washer - *Blue colour* (item 7) - This washer is placed behind the last recuperator sleeve against the bolt flange. As soon as the washer shows signs of wear on the outside edge, it should be replaced.



DO NOT NEGLECT THE BUFFERS. TOOL PERFORMANCE WILL BE DIMINISHED IF THESE PARTS ARE NOT IN GOOD CONDITION

- 6.3 Recuperator sleeves (item 3) - A full set comprises eight sleeves. Number 1 and 8 on the bolt will be the first to show signs of wear. They should be repositioned into a middle position. Once they become badly worn and start to fray, they should be replaced.
7. Chamber Cleaning - Assemble the chamber brush shown in fig. 8.01 and the chamber mop shown in fig. 8.02 to the brush and mop handle fig 8.03, screwing together hand tight. Using the brush end, insert via the open barrel end, into the cartridge chamber, and with a turning action, push in and out of the chamber to remove all powder residue. Young's 303 fluid can be used if the powder is difficult to remove. Apply some pistol oil to the mop head. Insert via the open barrel end into the cartridge chamber, and with a turning action, push in and out of the chamber to remove any remaining residue or powder.
8. Clean the inside of the breech cap with a cloth soaked in pistol oil and then wipe dry with a clean cloth.

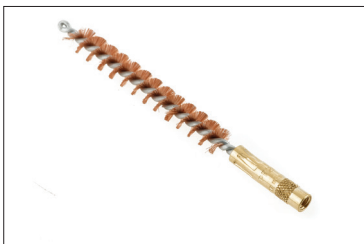

FIG. 8.01



FIG. 8.02



FIG. 8.03

CLEANING WEEKLY - CASH® Magnum Auto**ADDITIONAL CLEANING AND MAINTENANCE FREQUENCY DEPENDING ON USE, BUT MINIMUM WEEKLY.**

1. Remove the breech cap (item 26) and replace if worn or split. **NOTE** - if breech cover is ballooned out or cracked, replace the breech cover before further use. When re-fitting the breech cover, use lubrication to assist with sliding it back on to the breech. Ensure the cover is pushed on until the inner flange touches the mating shoulder on the breech.
2. Remove extractor (item 20) for cleaning by depressing the extractor plunger (item 18) and sliding the extractor over the plunger. The area under the extractor as well as the breech threads should be cleaned with the brass brush end of the cleaner assembly.
3. To dis-assemble breech cap (item 6) for cleaning or part replacement, hold in soft jawed vice and unscrew spring cap (item 27) or the stop fire assembly (item 15A), if fitted, using a wrench on the flats. Pull firing pin assembly out of breech cap, which will also release trigger and trigger spring. Inspect firing pin (item 16) for rounded edges from trigger contact and replace if wear is half of trigger contact. Inspect firing pin spring (item 10) and replace if broken or collapsed. Inspect trigger (item 17) for firing pin contact wear and replace if rounding is half of firing pin contact. Replace trigger spring (item 9) if collapsed. Trigger spring must be strong enough to push firing pin away from cartridge and to allow trigger to lift. In order to replace firing pin, firing pin spring or spring cap or stop fire assembly, unscrew pull (item 11) from pull bush (item 22), push pull bush down to release pull split bush (item 23), allowing all components to slide off. Rubber pull spring (item 25) should be re-placed if collapsed or damaged. Re-assembly: Wipe all steel parts with a cloth soaked in pistol oil. Do not put oil in cartridge chamber, as this can cause misfiring.



ONLY PERSONNEL WHO HAVE BEEN AUTHORISED TO DO SO SHOULD CONDUCT ANY RECTIFICATION IDENTIFIED IN THIS TROUBLESHOOTING SECTION



- ALWAYS WEAR THE CORRECT PERSONAL PROTECTIVE EQUIPMENT (PPE) WHENEVER YOU ARE WORKING WITH, CLEANING OR MAINTAINING YOUR CASH® TOOL
- ALWAYS WEAR PROTECTIVE GLASSES AND HEARING PROTECTION. THE CORRECT FOOT PROTECTION MUST BE WORN THERE IS A RISK THAT IF THE TOOL IS DROPPED, THE BOLT MAY PENETRATE THE FOOT OF THE TOOL USER

SYMPTOMS	CAUSES	ACTION
<ul style="list-style-type: none"> ▪ Cartridge misfires 	<ul style="list-style-type: none"> ▪ Firing pin failing to make contact with cartridge ▪ Water or oil-contaminated cartridges ▪ Oil in cartridge chamber 	<ul style="list-style-type: none"> ▪ If no indent is visible on the cartridge head, refer to corrective procedure on the next page ▪ Use a new box of cartridges ▪ Remove oil and clean the chamber
<ul style="list-style-type: none"> ▪ Bolt does not return fully into the barrel 	<ul style="list-style-type: none"> ▪ Incomplete set of recuperator sleeves and washers ▪ Worn washers and recuperator sleeves ▪ Build-up of carbon deposits on piston, breech and in chamber ▪ Bolt is bent 	<ul style="list-style-type: none"> ▪ Check and make good, as necessary ▪ Check and replace as necessary ▪ Check and remove by cleaning as instructed in section 8 ▪ Replace immediately
<ul style="list-style-type: none"> ▪ Stunner fires, but there is insufficient power to stun the animal (refer to section 5 in this manual, for the physical signs of an effective stun) 	<ul style="list-style-type: none"> ▪ Corrosion inside barrel ▪ Incorrect strength of cartridge being used ▪ Incorrect positioning of stunner on animal ▪ Bolt not returning fully to the breech after each shot 	<ul style="list-style-type: none"> ▪ Check and remove if present ▪ Check type of cartridge against product code of stunner and animals being stunned by referring to section 5 in this manual ▪ Check correct stunning position for type of animal being stunned by referring to section 5 in this manual ▪ Check for carbon deposits on bolt, breech or in chamber and remove by cleaning as instructed in section 8 in this manual ▪ Check recuperator sleeves, washers and collars for wear and replace as necessary ▪ Check number of washers, recuperator sleeves and collars make good as necessary
<ul style="list-style-type: none"> ▪ Bolt sticks in animal's head 	<ul style="list-style-type: none"> ▪ Bolt is bent ▪ Excessive build up of dirt in tool ▪ Recuperator sleeves excessively worn or missing ▪ Cutting edge of bolt narrower than shaft due to incorrect sharpening 	<ul style="list-style-type: none"> ▪ Replace immediately ▪ Conduct cleaning as instructed in section 8 of this manual ▪ Check and replace as necessary ▪ Replace bolt and sharpen by grinding the inside diameter only
<ul style="list-style-type: none"> ▪ Cartridge stuck or difficult to extract 	<ul style="list-style-type: none"> ▪ Split cartridge or damaged cartridge chamber ▪ Cartridge chamber not clean 	<ul style="list-style-type: none"> ▪ Return tool to maintenance department for removal and repair ▪ Refer to corrective procedure on next page ▪ Refer to section 8 for chamber cleaning instructions
<ul style="list-style-type: none"> ▪ Unusually load noise when fired 	<ul style="list-style-type: none"> ▪ Split cartridge 	<ul style="list-style-type: none"> ▪ Check for damaged cartridge chamber/ breech, return to manufacturer for repair ▪ Check that the correct cartridge is being used



ALWAYS POINT THE TOOL AWAY FROM YOUR BODY AND AWAY FROM ANY OTHER PERSON IN THE VICINITY WHEN HANDLING OR OPERATING THE TOOL

SAFE MISFIRE REMOVAL

If the cartridge does not fire, follow the procedure below:

1. Holding the tool with the muzzle pointing away from you or any other person, do nothing and wait for at least 30 seconds before continuing.
2. Turn the breech cap (item 6) counter clockwise and unscrew until the breech cap and barrel (item 1) are separate.
3. Observe if the cartridge is wet, oily or dirty.
4. Look at the cartridge head - if it has been struck, drop the cartridge into a water-filled metal container to make safe;
5. If there is no indent, follow the corrective procedure below.
6. Clean the cartridge chamber using chamber brush and mop and a soft cloth before testing with a new cartridge.
7. If the tool misfires a second time, remove it from the work area as it requires further investigative work and servicing.

MISFIRE - CORRECTIVE ACTION WHEN THE FIRING PIN DOES NOT STRIKE THE HEAD

If no indent is visible on the cartridge head, strip down the tool and check the condition and operation of the parts.

- Worn or damaged firing pin (item 16) - replace pin.
- Worn or damaged cartridge chamber - tool has surpassed its expected usage – we recommend the purchase of a new stunning tool.
- Test the tool after every corrective action to make sure that the tool is working correctly before putting back into operation.

TRAPPED OR STUCK CARTRIDGE REMOVAL

To remove a cartridge that is stuck and will not eject using the extractor:

1. Unscrew and remove the barrel (item 1) from the tool.
2. Remove the buffers and bolt (items 2, 3 and 7).
3. Grip the breech in a soft jawed vice.
4. Using a push rod of 4.5 mm (3/16") diameter, insert into the breech and gently push out the cartridge through the cartridge chamber.
5. Reassemble using reverse procedure to above.
6. Clean the cartridge chamber with the chamber brush and mop as detailed in section 8 of this manual.
7. If the tool misfires a second time, remove it from the work area as it requires further investigative work and servicing.



DO NOT ATTEMPT TO USE THIS STUNNING TOOL UNTIL YOU HAVE READ AND UNDERSTOOD THESE INSTRUCTIONS



- ALWAYS WEAR THE CORRECT PERSONAL PROTECTIVE EQUIPMENT (PPE) WHENEVER YOU ARE WORKING WITH, CLEANING OR MAINTAINING YOUR CASH® TOOL
- ALWAYS WEAR PROTECTIVE GLASSES AND HEARING PROTECTION. THE CORRECT FOOT PROTECTION MUST BE WORN THERE IS A RISK THAT IF THE TOOL IS DROPPED, THE BOLT MAY PENETRATE THE FOOT OF THE TOOL USER



ALWAYS POINT THE TOOL AWAY FROM YOUR BODY AND AWAY FROM ANY OTHER PERSON IN THE VICINITY WHEN HANDLING OR OPERATING THE TOOL

ALL TOOLS AND ACCESSORIES SHOULD BE AT LEAST SERVICED AND CALIBRATED ANNUALLY.

To dis-assemble the stop fire mechanism (item 15A):

1. Turn clockwise to fire *RED DOT* position and drive stop pin (item 15) down through cap inner (item 12) with a pin punch.
2. Then unscrew the stop fire cap (item 14) anti-clockwise to remove.
3. Clean with pistol oil and brass brush end of the cleaning tool.
4. Inspect for cracks or stripped threads and replace if found.
5. Replace O-ring (item 13) if broken or frayed.

Re-assembly of the stop fire mechanism:

1. Lightly oil or grease threads with Copaslip.
2. Align the small dimple on the end face of the cap inner with the cut out in the lower edge of the stop fire cap - this will ensure that the 3 start thread commences location in the correct position, so that when screwed together clockwise, the cut out on stop fire cap aligns precisely with the *RED DOT* mark on the inner cap, which should be fully visible.
3. Insert stop pin and drive flush with top of stop fire cap (if pin is driven too far, the assembly will not turn).
4. Re-assemble onto firing pin assembly and screw down tight on breech cap, using wrench on flats of cap inner.
5. If the stop fire cap is used to screw or unscrew the stop fire assembly from breech cap, you will break the stop pin.

ONLY EVER USE GENUINE ACCLES & SHELVOKE REPLACEMENT PARTS. NOT USING GENUINE PARTS MAY LEAD TO PREMATURE COMPONENT AND TOOL FAILURE, WHICH COULD ENDANGER THE OPERATOR AND THOSE IN THE IMMEDIATE VICINITY. IT WILL ALSO INVALIDATE OUR ORIGINAL EQUIPMENT WARRANTY.

ACCLES & SHELVOKE WILL ACCEPT NO LIABILITY IF ANY COMPONENTS OTHER THAN THOSE SUPPLIED BY ACCLES & SHELVOKE ARE USED WITH OUR ORIGINAL EQUIPMENT. THE RESULTANT LIABILITY WILL BE WITH THE END USER OR THE DISTRIBUTOR WHO SUPPLIED THE UNAPPROVED REPLACEMENT PARTS.

Frontmatec Accles & Shelvoke provide a comprehensive service and repair facility where customers can have their **CASH®** stunner serviced by our highly experienced and trained engineers. This service is generally open to UK customers. Overseas customers are advised to contact their local distributor.

- A quotation will be provided on inspection of the return of the tool, itemising service charges and replacement parts required.
- The service involves the tool being stripped, cleaned and reassembled with the replacement parts quoted to return the tool back to good working order.

Customers are advised to contact Frontmatec Accles & Shelvoke direct on +44(0)121 313 3564 to make arrangements to return the tool for service and repair.

ONLY EVER USE GENUINE ACCLES & SHELVOKE REPLACEMENT PARTS. NOT USING GENUINE PARTS MAY LEAD TO PREMATURE COMPONENT AND TOOL FAILURE, WHICH COULD ENDANGER THE OPERATOR AND THOSE IN THE IMMEDIATE VICINITY. IT WILL ALSO INVALIDATE OUR ORIGINAL EQUIPMENT WARRANTY.

ACCLES & SHELVOKE WILL ACCEPT NO LIABILITY IF ANY COMPONENTS OTHER THAN THOSE SUPPLIED BY ACCLES & SHELVOKE ARE USED WITH OUR ORIGINAL EQUIPMENT. THE RESULTANT LIABILITY WILL BE WITH THE END USER OR THE DISTRIBUTOR WHO SUPPLIED THE UNAPPROVED REPLACEMENT PARTS.

FIG. 11.01

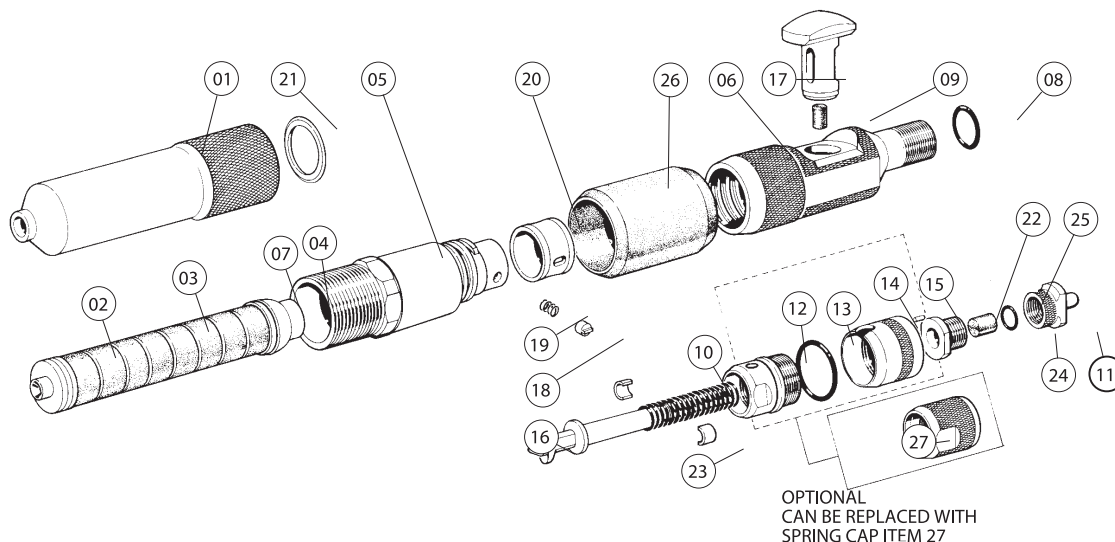

Item no.	Part description	Qty per set	SPARE PART BY PRODUCT CODE			
			5652AS	5652R	5660	5660S
1	Barrel	1	5723		5727	
2	Stop washer	3	5369			
3	Recuperator sleeve	8	5376			
4	Bolt	1	5684			
5	Breech	1	5724R		5734R	
6	Breech cap	1	5725		5707	
7	Flange washer	1	5403			
8	Small O-ring	1	5627			
9	Trigger spring	1	5628			
10	Firing pin spring	1	5755			
11	Pull	1	5702			
12	Cap inner	1	5693			
13	O-ring	1	5695			
14	Stop fire cap	1	5692			
15	Stop pin	1	3036			
15A	Stop fire assembly (complete)	1	5691			
16	Firing pin	1	5698		5690	
17	Trigger	1	5689			
18	Extractor plunger	1	5636			
19	Plunger spring	1	5637			
20	Extractor	1	5651R		5638	
21	Lock washer	1	5639			
22	Pull bush	1	5640			
23	Pull split bush (pair)	1	5641			
24	Pull lock O-ring	1	5642			
25	Rubber pull spring	1	5710			
26	Breech locking cover	1	5664			
27	Spring cap	1	5696			

Contact us today to find out how Accles & Shelvoke can help your current or future stunning requirements.

For customers based in Canada and USA:

Frontmatec Accles & Shelvoke Ltd
73 Victory Highway, West Greenwich
Rhode Island 02817
USA

Phone: +1 800 396 9497
Fax: +1 401 397 5031
E-mail: birmingham@frontmatec.com
accles-shelvoke.com
frontmatec.com

For all other customers:

Frontmatec Accles & Shelvoke Ltd
Unit 5A, Maybrook Road, Maybrook Business Park
Minworth Sutton Coldfield
Birmingham, West Midlands
UK B76 1 AL

Phone: +44 121 313 3564
Fax: +44 121 313 0282
E-mail: birmingham@frontmatec.com
accles-shelvoke.com
frontmatec.com

WARRANTY

The Accles & Shelvoke product warranty policy is available upon request. The product warranty policy, like any other, is conditional.

Your tool has been assembled, tested and proof-stamped as a mark of its performance, quality and safety, and arrives with you in full working order.

Your **CASH®** Magnum Auto has been designed and developed over 100 years of experience in the meat processing industry. It has proven to be a very reliable and robust tool if cleaned and maintained in accordance with this instruction manual.

In the event of any problems, please contact your local distributor.

RECYCLING



Once any component or tool has surpassed its useful life, it needs to be disposed of in a responsible manner. Most of the materials from which the Accles & Shelvoke range of stunning tools is manufactured can be recycled.

These materials must be correctly separated before they can be recycled. To do so, disassemble the tool, and sort into the groups highlighted in the table below. Use the spare parts list and diagram (section 11) to help with identification.

The disassembled and sorted items may be disposed of at an appropriate recycling facility.



Items/parts	Main material	Disposal
All components itemised in the <i>Spare Parts List and Diagram</i> except those detailed below	Steel	Ferrous metal recycling
2, 3, 7, 8, 9, 13, 19, 21, 24, 25, 26	Rubber	General waste
Spent cartridges	Brass	Non-ferrous metal recycling
Packaging cardboard	Cardboard	Cardboard recycling
Packaging plastic	Plastic	Plastics recycling
Other non-specified items	Various	General waste

EC DECLARATION OF CONFORMITY

Manufacturer's name and full address	FRONTMATEC Accles & Shelvoke Unit 5A, Maybrook Road, Maybrook Business Park, Sutton Coldfield, Birmingham, United Kingdom, B76 1AL
Authorised Representative and full address	Frontmatec Hygiene GmbH b + c, Auf dem Tigge 60, 59269 Beckum, Germany
Description and identification of the machinery	
Product/Type	Cartridge Powered Captive Bolt Animal Stunning Tool
Model	CASH Magnum
Function	Animal Stunning
Commercial Name	CASH Magnum
Other identifying information	
This machinery conforms to all the requirements of the Machinery Directive 2006/42/EC	
This machinery also conforms to the following Directives	EU Council Regulation (EC) No 1099/2009 on the protection of animals at the time of killing; The Gun Barrel Proof Act 1978
The following standards have been used	EN ISO 12100:2010
The machinery has been examined by	 kuiper certificering b.v. Van Slingelandtstraat 75, 7331 NM Apeldoorn, The Netherlands
Notified Body No.	2842
Certificate Number	KCEC3847-3
The technical file is compiled in accordance with part A of Annex VII of the Machinery Directive 2006/42/EC	
Name and address of the person authorised to compile the technical file (based in the European Community)	Frontmatec Hygiene GmbH b + c, Auf dem Tigge 60, 59269 Beckum, Germany
Person authorised to make this declaration	FRONTMATEC Accles & Shelvoke
Name	Friedhelm Albert
Function	Documentation Engineer
Signature	
Place of Declaration	
Date of Declaration	



UK DECLARATION OF CONFORMITY

Manufacturer's name and full address	FRONTMATEC Accles & Shelvocke Unit 5A, Maybrook Road, Maybrook Business Park, Sutton Coldfield, Birmingham, United Kingdom, B76 1AL
Description and identification of the machinery	
Product / Type	Cartridge Powered Captive Bolt Animal Stunning Tool
Model	CASH Magnum
Function	Animal Stunning
Commercial Name	CASH Magnum
Other identifying information	
This machinery fulfils all the relevant provisions of the Supply of Machinery (Safety) Regulations 2008 (SI 2008/1597) as amended (SI 2011/1043, SI 2011/2157, SI 2019/696).	
This machinery also conforms to the following Directives: The Welfare of Animals at the Time of Killing (England) Regulations 2015, The Gun Barrel Proof Act 1978	
The following standards have been used	EN ISO 12100:2010
The machinery has been examined by	 amtri veritas ltd , veritas house, pierce street, Macclesfield, SK11 6ER, UK
Approved Body no.	0463
Certificate no.	AVUK3847-3
Name and address of the person authorised to compile the technical file (based in the UK)	FRONTMATEC Accles & Shelvocke Unit 5A, Maybrook Road, Maybrook Business Park, Sutton Coldfield, Birmingham, United Kingdom, B76 1AL
Person authorised to make this declaration	FRONTMATEC Accles & Shelvocke
Name	Joe Mansfield
Function	Operations Manager
Signature	
Place of Declaration	
Date of Declaration	